



Specifications

MODEL

- PT96827 FREESTANDING TUB FILLER - CHROME
- PT96826 FREESTANDING TUB FILLER - BRUSHED NICKEL
- PT96817 FREESTANDING TUB FILLER - MATTE BLACK
- PT96818 FREESTANDING TUB FILLER - BRUSHED BRONZE

FEATURES

- Ceramic Cartridge
- Lever Style Handle
- 1/2" IPS connections
- Min Flow Rate: 2.4 gpm at 20 PSI
- Hand Shower Max Flow Rate: 1.8gpm at 80 PSI
- **PT61000 ROUGH-IN MANIFOLD KIT REQUIRED FOR CONCRETE INSTALLATIONS**

CODE COMPLIANCE

- ASME A112.18.1 / CSA B125.1
- IAPMO Certified

WARRANTY

- Limited Lifetime Warranty

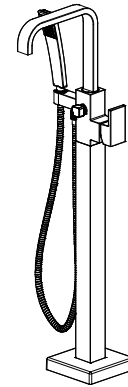

FREESTANDING TUB FILLER

MODEL	FINISH
PT96827	Chrome
PT96826	Brushed Nickel
PT96817	Matte Black
PT96818	Brushed Bronze

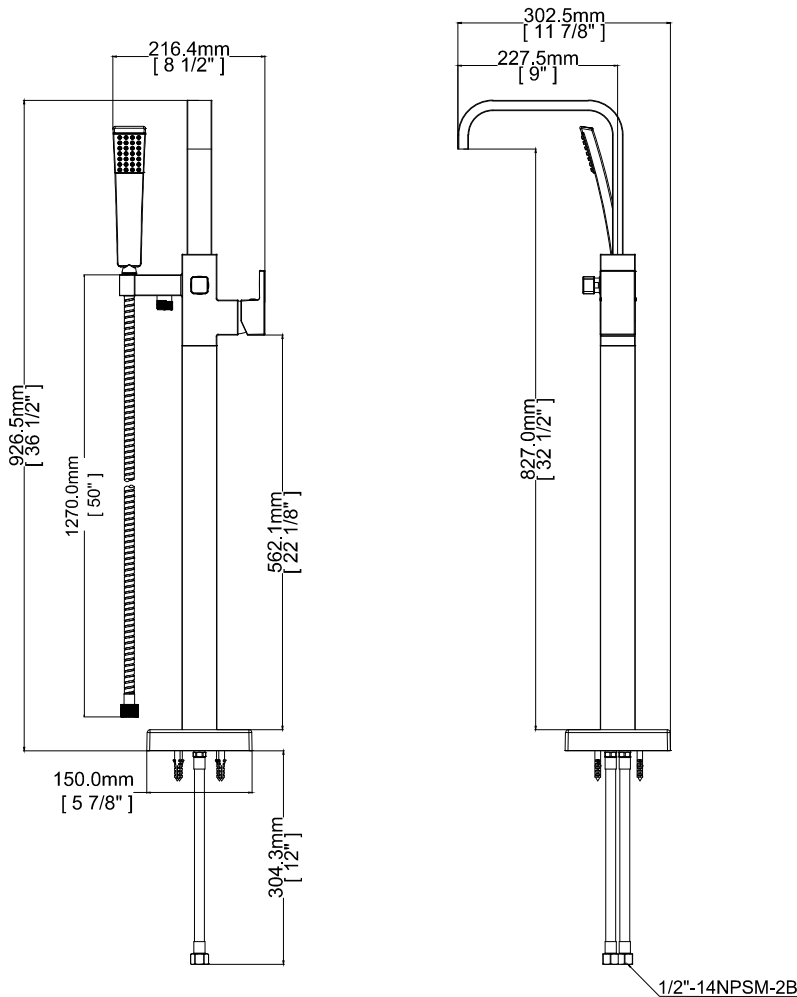

INSTALLATION DIMENSIONS

Jacuzzi reserves the right to make changes in specifications and materials and to change and discontinue models, both without the notice or obligation. Dimensions are for reference only.